

B-B (1:1)

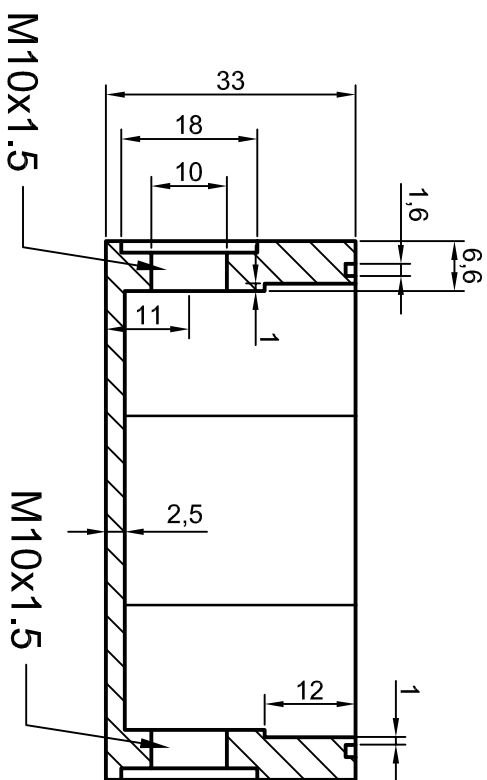

A-A (1:1)

